



Food Safety

X-RAY INSPECTION

RAYCON

Product family overview

The next generation of RAYCON

Auto-learn function

The Auto-Learn function offers a simple and intuitive operation. The configuration of various filters is performed by the device itself, considerably reducing effort on the part of the user. Even the detection sensitivity is automatically adjusted. Auto-learning takes fewer than two minutes for each new product using five product samples.



New software features

"Bone Detector," "Wirefinder," and "Glass Increaser" are new filters that boost accuracy in the detection of specific contaminants. Also available: Sensitivity prediction (configuring the machine virtually, without test pieces); Integrated Compliance Monitoring for extra safety (automatic controls for standard requirements in 10-minute intervals to minimize errors)

Modular build of D+ devices

RAYCON D+ MX and HX have modular builds which allow the systems to be precisely adapted to your production line. They also offer a variety of upgrade possibilities including detectors, cooling devices, conveyance directions, operator panels, rejection units, software features and more.

UL/CSA certified

All RAYCON devices are certified with UL/CSA.



Made in Germany

All RAYCON devices are developed and manufactured in Germany.



Functionality

The system consists of these main components:

- A** X-ray tubes: Tubes electrically generate the x-ray beams. The beam exits through a small slit and passes through the product, layer by layer from the bottom up.
- B** X-ray beam
- C** Transport system: A self-driven flat belt made from PE transports the products evenly through the x-ray beam. This makes it possible to capture every layer of the product.
- D** Detector unit: The linear detector is installed above the inspection opening and converts the incoming x-ray beams into an electric signal from which an x-ray image is generated.
- E** Industrial PC: Here, the image is analyzed, and the rejection system is triggered as necessary.

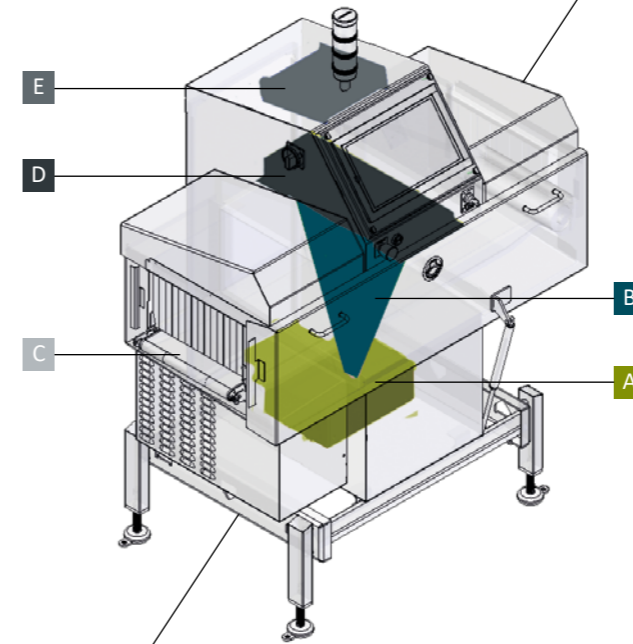

X-Ray AI-Technology: THiNK X

The X-ray AI technology called THiNK X enables precise detection of anomalies and foreign objects. It offers a wide range of applications and can even detect low-density contaminants. The AI model learns the characteristics of the product by being trained with a large number of good products. If a product deviates from these learned characteristics, it is identified as defective. This allows foreign objects to be accurately localized.

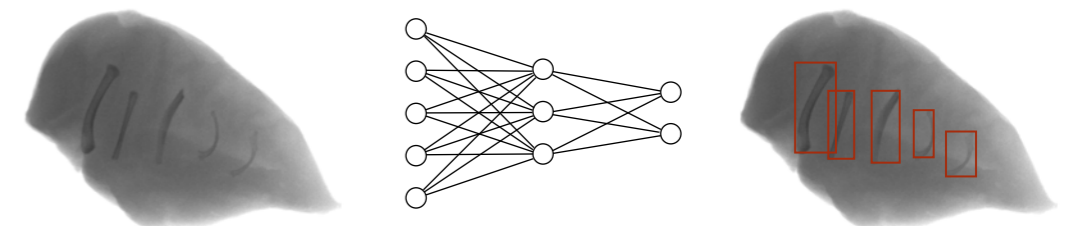

AI-powered detection: Left: undetected contaminants – Right: successfully detected.

X-ray inspection comprehensively designed

Product quality is the top priority of the food industry. In a worst-case scenario, distributing defective goods can have fatal consequences. It can also involve incredibly expensive product recalls, recourse claims, and consumer damage claims. We help give you peace of mind with finely tuned x-ray inspection technology. Our RAYCON x-ray inspection systems were developed specifically for the food industry. They quickly and reliably detect a diverse range of physical contaminants in packaged and unpacked food products, regardless of their size, shape, or position. They can be used in the middle of a production line to inspect bulk materials or pre-products, or for end-of-line final product inspection.

Whether for mid-process inspection of bulk material and pre-products, or end-of-line inspection of packaged foods: our RAYCON systems ensure optimal food safety.

Typical fields of application in food production

We support food processors and manufacturers in creating only the best quality products. Our RAYCON systems are designed for use in the following branches:

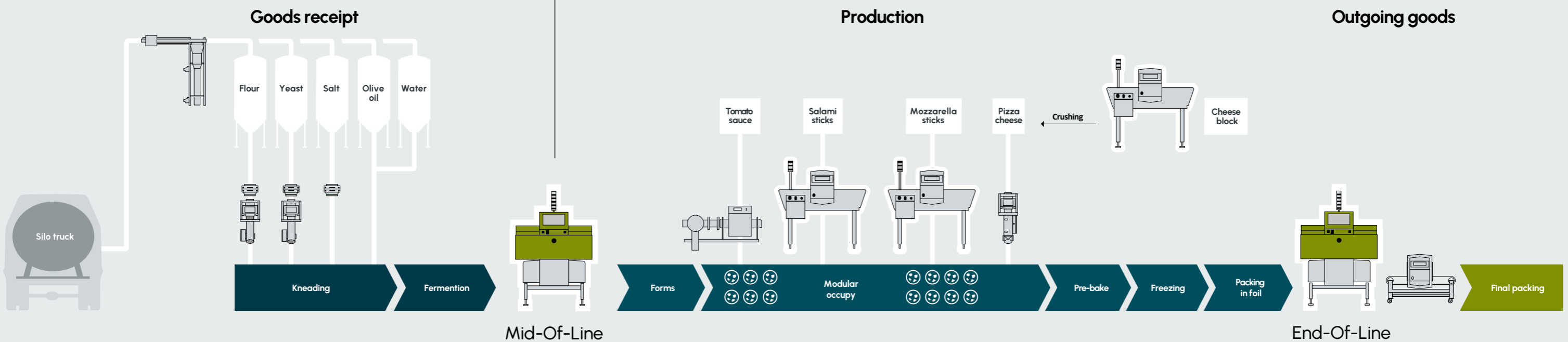
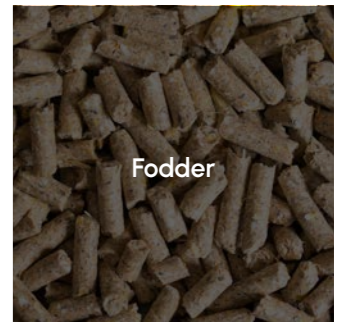
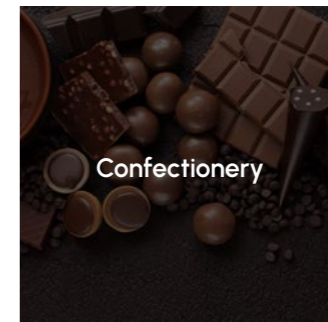
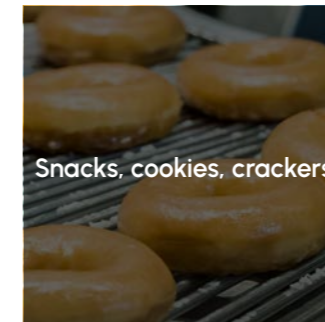
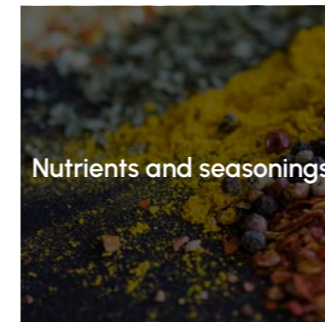
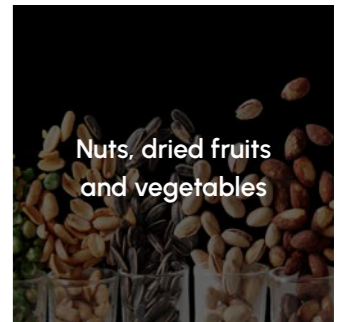
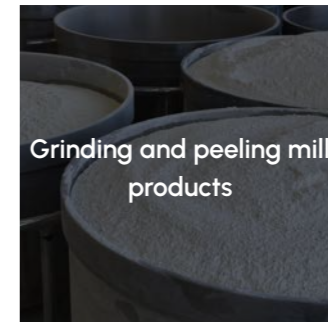
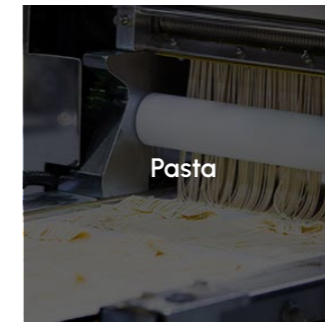
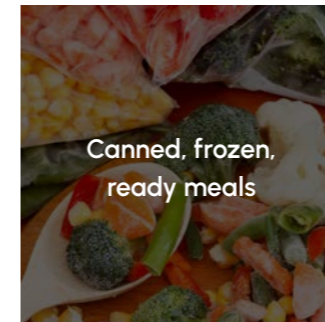
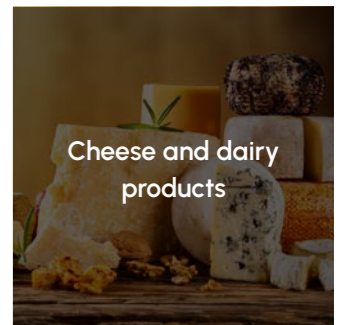
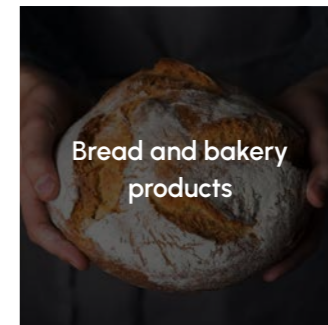
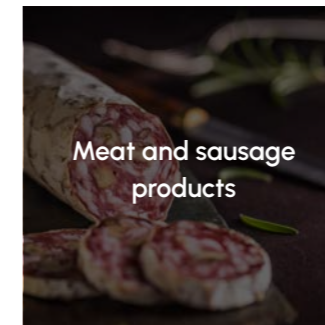

ALWAYS COMPLIANT – ALWAYS SAFE

The Compliance Package



Our compliance software package for seamless and efficient documentation consists of the Audit Check, Sensitivity Prediction, Compliance Mode, Integrated Compliance Monitoring (ICM) and Integrated Validation Process (IVP) functions. It helps customers meet food safety standards, increase production efficiency, enhance product quality, and more.

Audit-Check

Quality assurance 4.0: With the help of a process wizard, the Audit-Check leads through the audit routine and logs all steps. This continuous quality monitoring is of enormous importance, especially for food producers and processors, to ensure consistently high product quality.

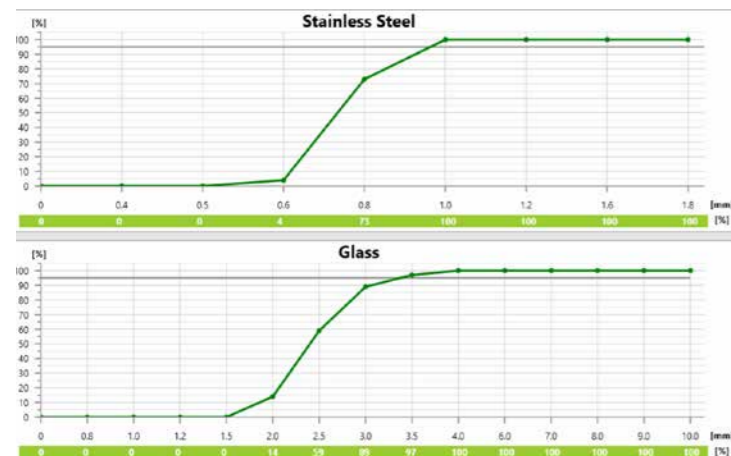
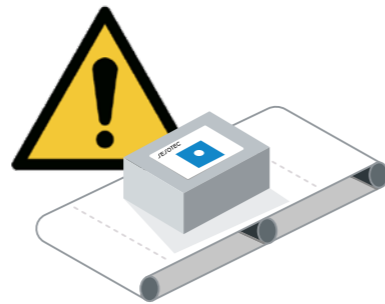

Grafische Darstellung der errechneten Detektionsempfindlichkeiten für Edelstahl und Glas.

Sensitivity Prediction

The „Sensitivity Prediction“ enables automatic determination of the detection sensitivity of stainless steel and glass during an X-ray inspection. The test cards with 100 test bodies made of glass and stainless steel are available in all sizes and stored in the software. This information is calculated along with the product's gray value image as if a product with a test sample were being recorded.

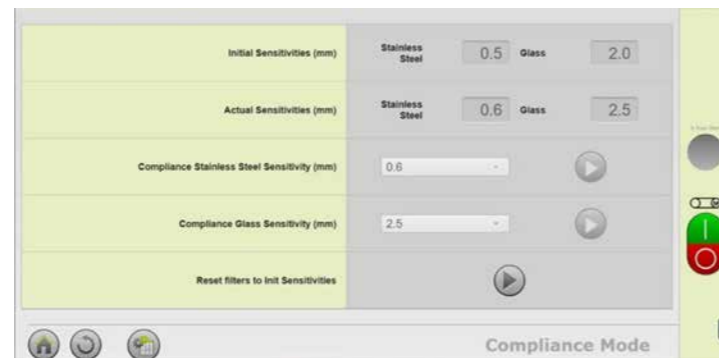

Compliance Mode

In compliance mode, the sensitivity can be set to factory or audit standards at the touch of a button to produce compliantly and at the same time reduce the false reject rate. This ensures that process stability is constantly maintained. In compliance mode, the X-ray unit adjusts the software filters accordingly during the teach-in process, to reliably detect the specified test specimens.



Integrated Compliance Monitoring (ICM)

Integrated compliance monitoring ensures that the specified sensitivities are continuously checked at previously defined time intervals. For this, test bodies stored in the software are compared with the product images and offset against the limit values matched. This monitoring of the detection requirements leads to deviations being recognised immediately and increases the stability of the production process.

Integrated Validation Process (IVP)

The Integrated Validation Process (IVP) provides proof that the desired quality target for the product has been achieved. The customer can validate new products independently with menu guidance and receives a „Report of Validation“, but this does not replace the validation certificate for the annual audit by an external service provider (manufacturer).

Advantages for the customer:

- Simplification of complex validation processes
- Reproducible, consistent and tamper-proof results

SESOTEC

Report of Validation

Report Number: Rep_0875412367_25042023_145144 Date of Validation: 25/04/2023 14:51:44
 Job Number: 7584 Date of Next Validation Due: 01.01.2024
 Company: Firmenname Validating Technician: Service
 Address: Regener Str. 130 Schoenberg, 94513 Contact: Sesotec Service
 Email Address: webcontact@sesotec.com Telephone: 085543080

Machine Configuration
 Model: Raycon D+ Aperture Size: 450/250
 Serial: 0875412367 Reject Type: Pusher
 Device Name: Raycon 1 X-Ray Voltage: 50 kV
 Line Name: 123456 X-Ray Current: 4 mA

Product Details
 Name: Pistazienkerne
 Length: 20 cm
 Width: 15 cm
 Height: 5 cm
 Temperature: 20
 Belt Speed: 0.9
 Pack Rate: 100

Test Sample Information	Test Sample Identification	Test Sample Density	Testcard	Validation Results		
				Probability of Detection	Confirmed Rejections	
Glass, 2.5 mm	33012776	2,5g/cm³	3	80	5/5	Failed
Stainless Steel, 1.0 mm	33012602	7,9g/cm³	3	100	5/5	Passed

For any questions or to schedule your next validation please contact Sesotec at 085543080 or at webcontact@sesotec.com
 Note: The test is performed with the metal sample at the leading edge, middle, and trailing edge of the product (if applicable). The validation was performed with certified test sticks which comply to NIST standards. Metal Detection results can be impacted by the product signals, the results listed above are based on the specific product that was used during this validation process.



Driving the AiVOLUTION

OBJECT DETECTION POWERED BY AI IMPROVES THE IDENTIFICATION OF FOREIGN OBJECTS

THiNK: Making the invisible visible

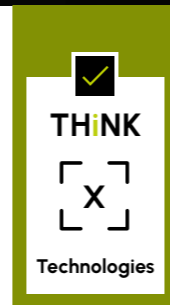

The issue:

The detection of certain well known objects which are visible for the human eye but show only minimal greyscale differences compared to products without this object - and therefore not detectable using conventional methods. The objects with characteristic forms can be trained in an AI model as good product for completeness check (e.g. spoon in the powder, baguette with herb filling) or as negative contamination (e.g. bone in chicken, broken sausage).

The solution: THiNK XO (Object detection)

An AI model can be trained on objects with specific characteristic shapes. These objects must be trained in all different positions.

There are two areas of application:

- 1 good objects can be identified and used to verify completeness
- 2 bad objects can be identified as a contermination

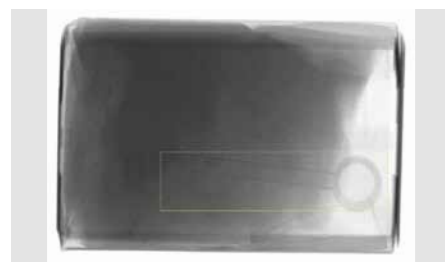

Detection of objects in product packages

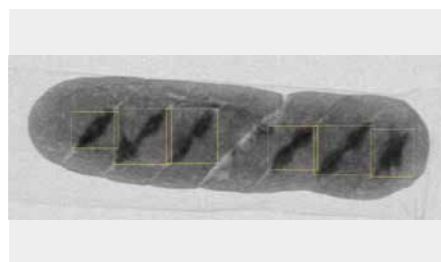

Detection of baguette herb fillings

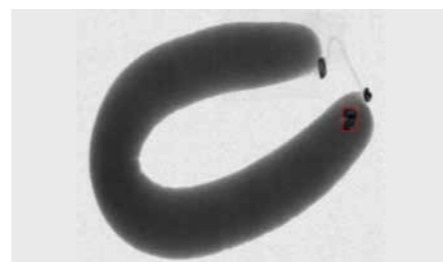

Detection of clip in the sausage

Typical application areas:

Detection of a defined number of good objects in a package:

- Spoon in powder
- herb filling in baguette
- sausage with two clips

Detection of contamination (well-known objects):

- bone fragments
- cable ties



Note:

The list of use cases can be expanded according to customer-specific requirements.

THiNK XA and XO can also be used in parallel, ensuring the best performance depending on the application.

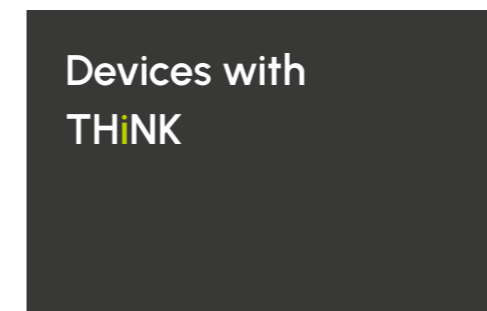

RAYCON D+ HX and RAYCON D+ TX



RAYCON D+ HX LW Hygienic and RAYCON D+ HX LW

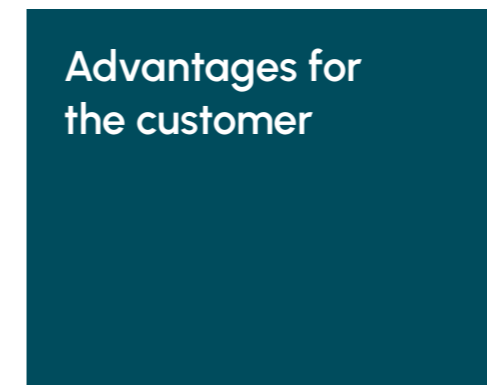

- Efficiency: reduces manual inspection and the shipment of defective products
- Quality: higher detection performance on difficult products with minimal greyscale differences
- Flexibility: Individual retraining of well-known optimizes detection performance.
- Innovation: Cutting-edge AI technology enhances detection capabilities and adapts to new challenges.



Driving the AiVOLUTION

ANOMALY DETECTION POWERED BY AI IMPROVES THE IDENTIFICATION OF FOREIGN OBJECTS

THiNK: X-ray Perfection in detection

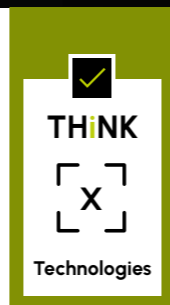

The issue:

Detection of contaminants and product defects in packaged and unpackaged products that are visible to the human eye but show only minimal grayscale differences compared to good products – and are therefore not detectable using conventional methods. Reliable bone detection in fresh meat is challenging, as bone fragments often have low density and the product itself is inhomogeneous. This makes it difficult to distinguish between bone and meat, especially when using conventional inspection methods.

The solution: THiNK XA (Anomaly Detection)

The AI model learns the characteristics of the product. To do this, a certain number of good products are used to train the model. If a product deviates from these learned characteristics, it is identified as defective. This allows foreign objects and anomalies to be accurately localized.

Typical examples are:

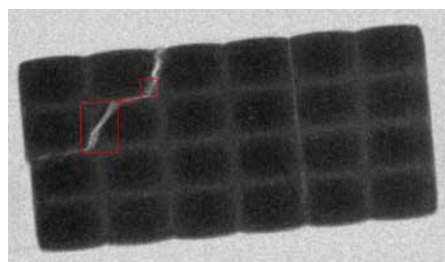

Defective/deformed product

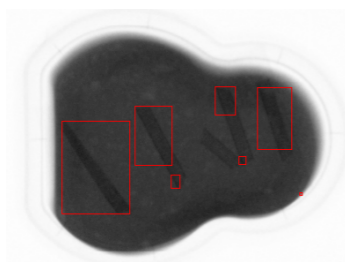

cable tie in spreadable sausage

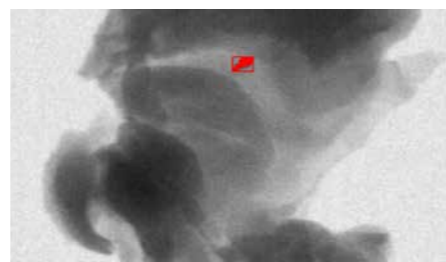

Bone detection in meat

Typical application areas:

For packed products:

- Detection of defective and deformed products
- Identification of cable ties

For unpacked products:

- Improved plastic detection
- Enhanced bone and cartilage detection in fresh meat applications (e.g. inner fillet, outer fillet, thigh meat, upper leg meat, etc.)



Note:

The list of use cases can be expanded according to customer-specific requirements.

THiNK XA and XO can also be used in parallel, ensuring the best performance depending on the application.

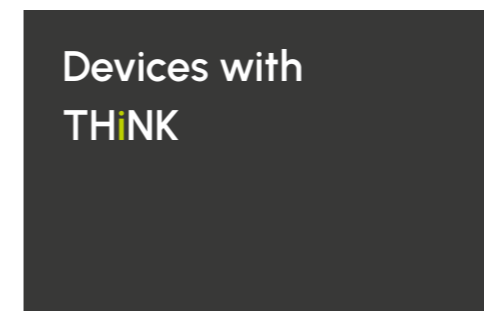

RAYCON D+ HX and RAYCON D+ TX



RAYCON D+ HX LW Hygienic and RAYCON D+ HX LW

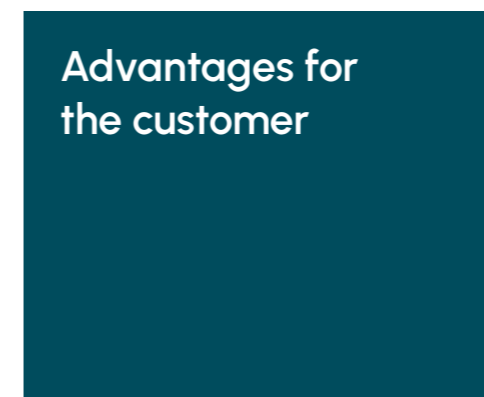

- Innovation: State-of-the-art technology precisely identifies foreign objects and anomalies.
- Quality: High detection accuracy ensures consistent product standards through parallel inspection using software filters and AI.
- Efficiency: Automated X-ray inspection detects anomalies quickly and saves time.
- Profitability: Customizable AI learns individual product characteristics and responds to deviations.

Your priorities. Our answers.

The development of our metal detection systems was focused on one thing in particular: Your priorities. In-depth analysis and background discussions have revealed the key requirements for foreign object detection. On this basis, we have intensively researched solutions. This has resulted in our Sesotec 6-priorities concept with practical answers to your challenges.



P1 **Conformity & Accuracy**

Reliable detection of magnetic and non-magnetic foreign objects throughout the inspection area enables compliance with all current specifications and standards.

P2 **Safety for people & product**

The automatic venting of the pneumatics in the event of an emergency stop and compressed air monitoring, as well as the ejection control, ensure all-round safe operation for people and products.

P3 **Simple operating concept**

Thanks to a large touchscreen, intuitive user guidance with quick access to the most important system functions, a help function and features such as the Auto-Learn function, our tunnel metal detectors offer particularly easy everyday handling.

P4 **Comprehensive hygiene concept**

Robust and hygienic housings allow easy cleaning.

P5 **Efficiency in all areas**

Intelligent sensitivity adjustment and high interference immunity prevent false positives and increase profitability.

P6 **Reliable, fast service**

With warranty services, combined on-site and remote service, and targeted training, you have optimal support for smooth operation.



Conformity & accuracy

RAYCON supports and facilitates compliance with necessary foodsafety standards and laws.

RAYCON exceeds international standards

With a RAYCON device, you can rest assured that you are conforming to international food safety standards.

- BRC-, IFS- and HACCP compliance (exceeds the requirements for detection accuracy stipulated in all common food safety standards)
- Higher Level Security Package (Quality standards from Marks & Spencer) is included as standard in all devices.



All RAYCON devices are UL/CSA certified and approved for use in the USA and Canada.



Sesotec Compliance Package: Software for complete and efficient documentation

- Audit-Check: Runs through audit routines and documents all steps (quality monitoring).
- Sensitivity Prediction: Enables the automatic configuration of detection sensitivity for steel and glass.
- Compliance Mode: The necessary detection accuracy can be configured manually. This ensures consistency and process stability.
- Compliance Monitoring: Ensures that current sensitivity levels are checked at pre-determined time intervals.
- Integrated Validation Process: The device includes an integrated multi-step process for the simplified verification of products.

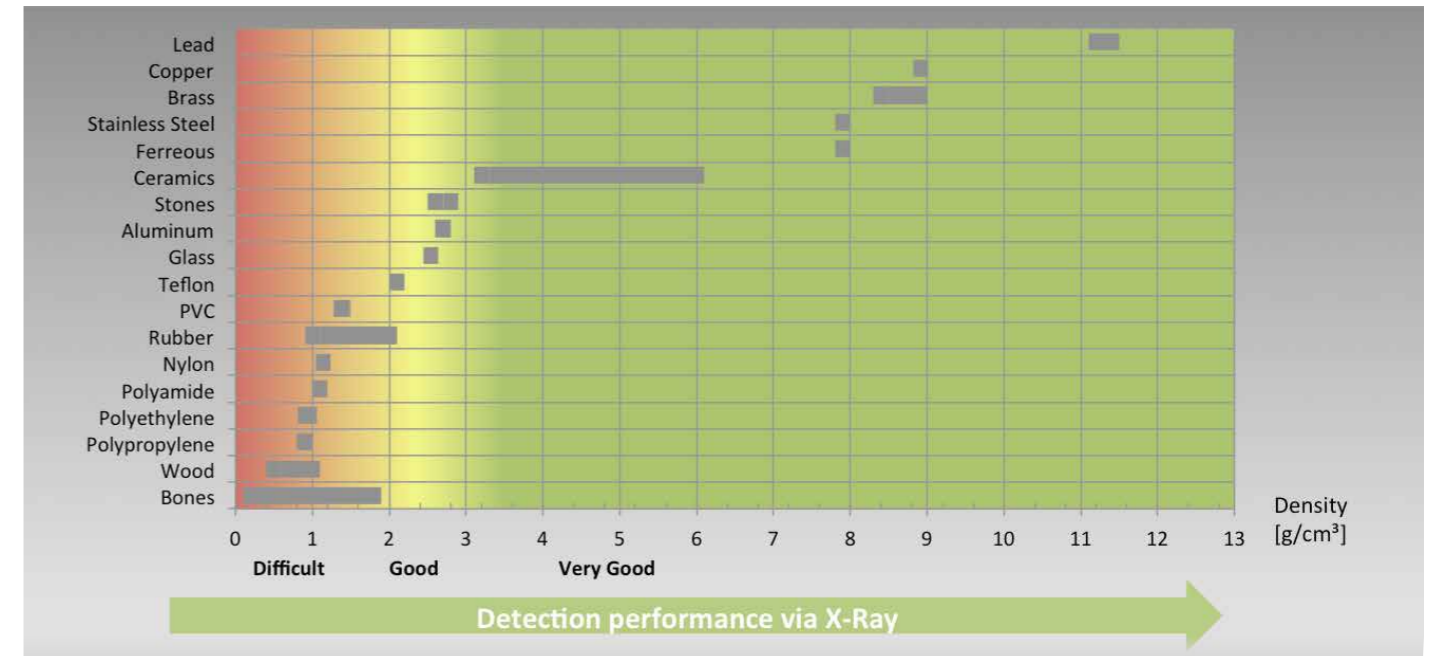

No dead angles

In RAYCON devices, the x-ray source is located beneath the conveyor belt. This eliminates dead angles in the inspection of tall products.

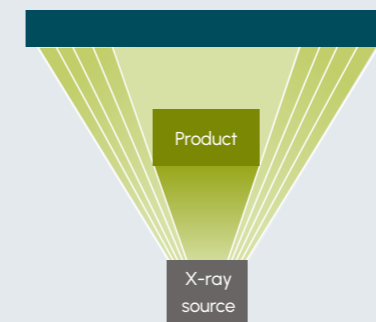

Flashlight effect

The large distance between the product and the detector makes it possible to detect foreign bodies that are smaller than the resolution of the detector.

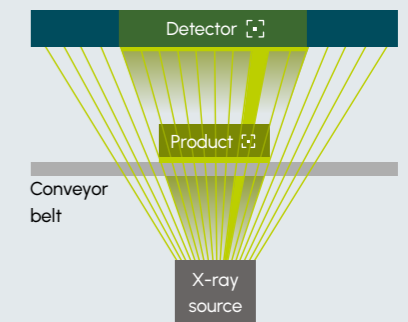

Detection accuracy

Reliable detection of various foreign bodies throughout the entire inspection area is a requirement for achieving conformity with all of the most common food safety standards and guidelines.

- Reliable detection of metallic and nonmetallic foreign bodies
- Detection accuracy from 0,3 to 0,6 mm exceeds the IFS requirements for stainless steel (0,8 mm)
- THINK enables the detection of additional low-density contaminants and product anomalies.





Safety for people & products

The system ensures safety for your brand, your products, your employees, and your data

Radiation protection: a top priority for you and us

Our RAYCON systems help you avoid recalls due to foreign bodies, protecting your brand from image damage. Thanks to highly effective radiation protection and precision x-ray dosing, RAYCON devices are safe for both people and products.

- The legal threshold of 1 mSv/a is never surpassed and radiation levels remain significantly beneath this threshold.
- At the operation panel, for instance, the radiation level is a mere 0.1 µSv/h (measured from the operation side in front of the device).
- The radiation exposure for products is 100 times lower than the thresholds defined in EU 1999/2/EG.
- Compatible with organic products



Guaranteed data safety

- Contactless user login via RFID chip ensures maximal access safety. An RFID transponder can both read data on the chip and save new data to it.
- Users can log in by holding their chip to the RFID reader, which is programmed to recognize each of the users assigned to each chip in user administration.
- Defining different user groups (e.g. Service, Admin, Operator) makes it possible to define access rights and provides an extra layer of protection.



Smart solutions for mechanical safety

Opening the cover automatically deactivates the x-ray beam and pneumatic system's air is de-energized, eliminating the air pressure in the pusher for extra safety.

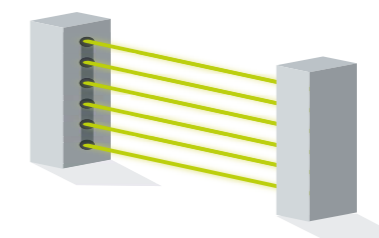

An additional lightbox at the opening is optional for US customers.

Sesotec Service for RAYCON x-ray devices

Mechanical engineering with x-rays involves many requirements for radiation protection and employee safety. Ongoing service from Sesotec helps you to safely install and operate your x-ray device.

For new Sesotec devices

- Organizing training for on-site specialists (R3) and parties tasked with overseeing radiation protection
- Single-day on-site training by Sesotec
- Instruction for operating personnel by Sesotec
- Expert examination (Assessment for initial installation)
- Registration and permissions
- Recurring regular examinations (every 5 years)
- Notifying relevant authorities of changes

For existing Sesotec devices

- Refresher courses for on-site specialists (R3) tasked with overseeing radiation protection, Instruction for new operators
- Recurring regular examinations for installed devices (every 5 years)
- Notifying relevant authorities of changes



Simple operating concept

Intuitive user operation doesn't just feel good – it also improves processes and minimizes the risk of error

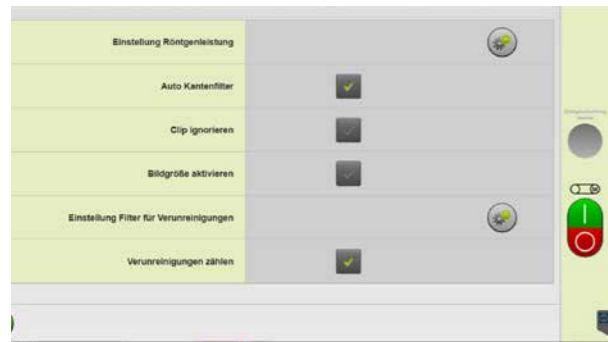

Auto-Learn menu



Menu-led, supported product learning

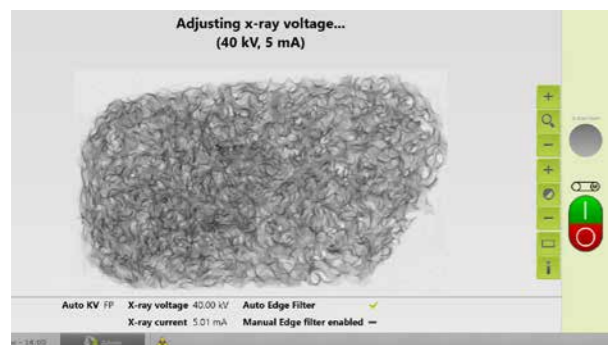

Automatic adjustment of the beam intensity depending on the product

Auto-learn function

Configuration and operation made easy:

- The Auto-Learn function offers simple and intuitive operation. Employees need not have specific skills or prior experience with image processing to operate the device.
- The configuration of diverse, specialized filters is performed by the device itself, relieving the user of this work.
- Using five product samples, auto-learning takes fewer than two minutes for each new product.

Clever software support

- Increased detection sensitivity: The "Ignore clip" function filters out metal clips, increasing sensitivity within the product – activated easily via a checkbox in the filter menu.
- Automatic edge detection: The software automatically detects packaging effects and adjusts the filter to match the product contours. No expert knowledge of filter techniques is required.
- Automatic X-ray source adjustment: RAYCON automatically sets the optimal X-ray power for maximum detection accuracy during the teach-in process (Auto kV).



Ignoring metal clips to increase detection sensitivity

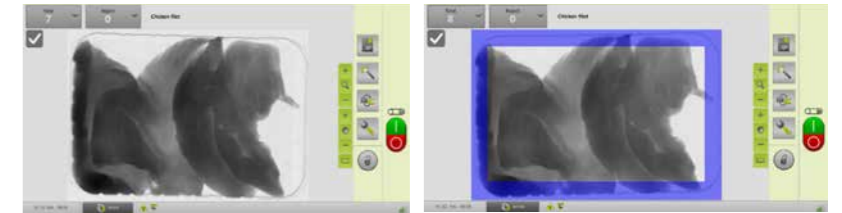

Automatic edge recognition for packaging



Front-end functionality for all operation and servicing

Operation, emptying the rejection compartment, cleaning, band change, etc.

Touch screen

10"/15" color touchscreen with high resolution and a user-friendly layout

USB connection

For simplified data transfer

RFID login

Contactless data transfer via RFID login for maximal access protection



Hygienic design concept

The system is built according to hygienic design principles and offers easy cleaning and maintenance

10%

Cleaning costs account for part of the annual revenue

Did you know that cleaning is one of the most time- and resource-intensive aspects of food production?

According to a study, 50% of companies invest at least 10% of their annual revenue in cleaning processes.

Highest hygiene standards – for food production

Constructed with stainless steel and food-safe plastics, RAYCON is ideal for use in food contact applications (EG1935/2004).

- Tilted surfaces discourage the build-up of liquids and condensation
- Built entirely from stainless steel and food contact approved plastics (EG1935/2004)
- Gaps, crevices, and other dead spaces are sealed off to prevent the accumulation of residue. Reduction of components that can loosen over time, presenting a contamination risk
- Use of materials that can withstand repeated, intensive cleaning without wear
- RAYCON D+ HX LW Hygienic for particularly high hygiene requirements, for example in the meat sector or for unpackaged, raw products



Mechanical advantages

- Simplified cleaning due to open, modular design
- Toolless access and disassembly of the conveyance area for cleaning and maintenance
- Suspension system for radiation protection curtains during cleaning help to reduce risk of recontamination
- Toolless belt replacement and toolless removal of radiation protection curtains in less than 2 minutes

Efficiency in all areas

Increasing output, avoiding food waste

Sophisticated technology for maximum productivity

- High detection accuracy minimizes false rejects, thereby wasting less food (sustainability)
- Expertly engineered and long-lasting core components with up to 200W x-ray source and detection accuracy from 0.3 mm of stainless steel
- Automatic notification x-ray source is approaching end-of-life (early warning system for planning source replacement service)
- Toolless beld and curtain change in just a few minutes

Added value that you can see

- Reliable detection of product defects: The software recognizes broken and misshapen products from within their packaging.
- Weight checking products and components: The software calculates the weight of the product based on dimensions and density, thereby recognizing weight differences among individual products in a line.
- Completion control: For each object marked for counting in the x-ray image, minimum amounts can be configured. Example: Counting chocolates
- THINK enables the detection of additional low-density foreign objects and product anomalies.

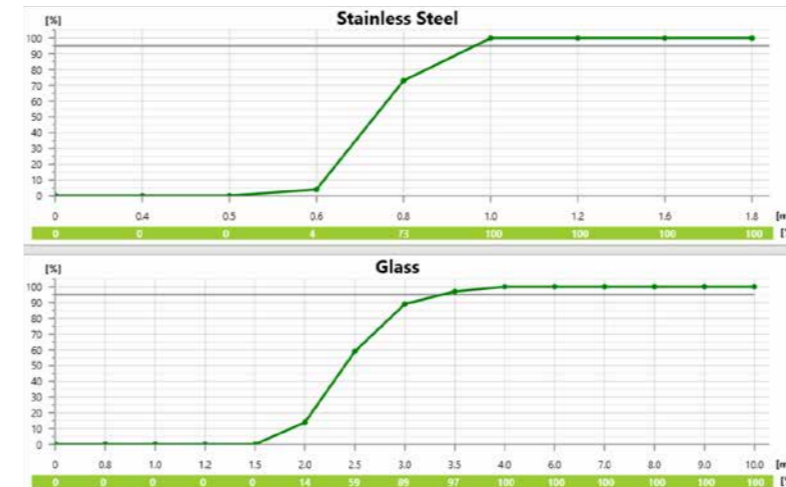

Graphic depiction of the calculated detection sensitivities for stainless steel and glass

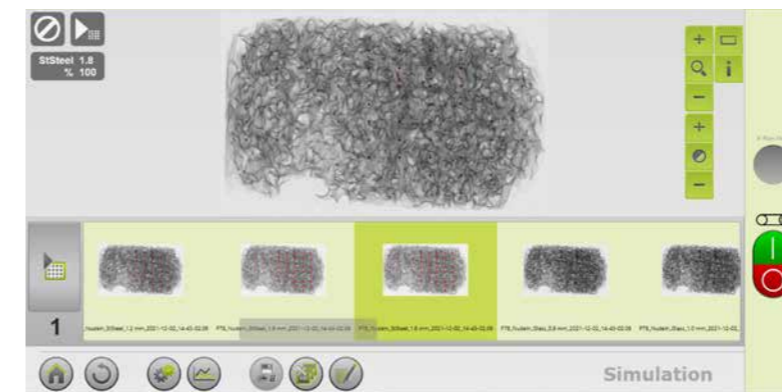

Simulation of test pieces for determining sensitivity

Sensitivity prediction and Compliance Monitoring

The software package "Sensitivity Prediction" makes it possible to automatically determine the best detection sensitivity for stainless steel and glass. Data about hundreds of test pieces for glass and stainless steel are stored in the software. This information is calculated along with the product's gray value image as if a product with a test piece were being recorded.

All information about detection sensitivity is calculated based on these images and displayed in a graph. The sensitivity calculations can be started manually from the menu or automatically performed directly following the learning function.

Integrated Compliance Monitoring ensures that specified sensitivities are continuously checked at predefined time intervals. Through regular controls of the detection requirements, deviations are immediately detected, increasing the consistency of the production process.

Up to
1,500
products/minute
thanks to real-time controls
(product & machine dependent)

1.4
meter/second
Suitable for high belt speeds
(product & machine dependent)

Multi-lane inspection

Simultaneously inspect up to four lines of identical products on a single x-ray inspection device. The products to be tested per line must always be the same.



Multi-product software

As many as 20 different products can be conveyed in any order. The software recognizes each product as it passes through the x-ray beam, and selects the appropriate parameters within milliseconds.

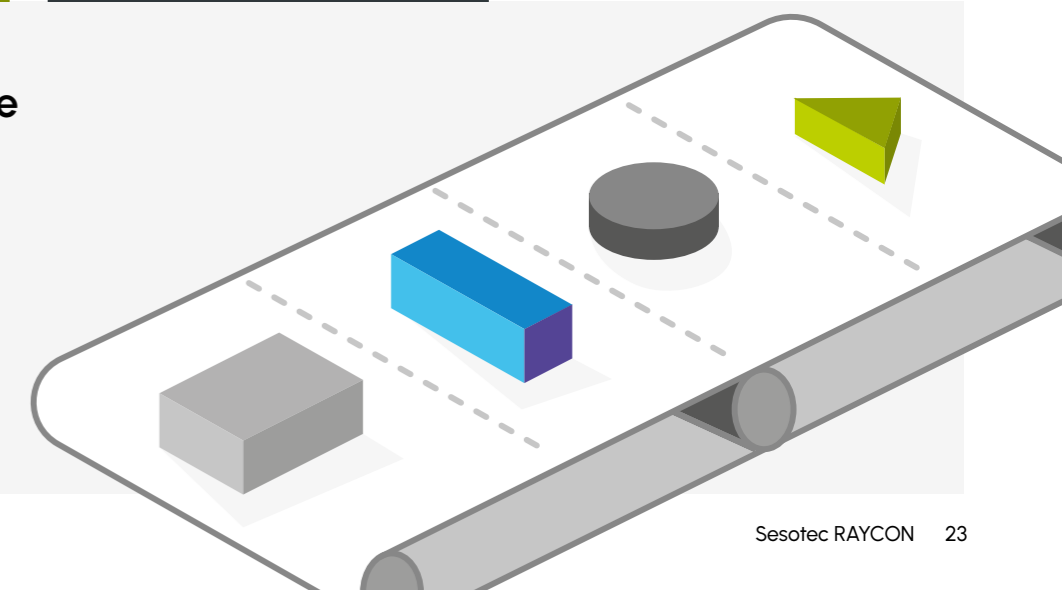

Reliable & fast service

Ensure continued performance and improvements, quick assistance in case of unplanned downtime, and problem prevention.

- Customer-specific trainings for proper operation, radiation protection, and service and maintenance
- Yearly maintenance and product validation
- Initial installation on-site by a qualified service technician
- Demo-devices delivered on short notice

The Sesotec communication style: Service. Global. Competent. Responsive.

In addition to first-class technologies for foreign body detection, Sesotec also offers first-class service. Broad knowledge and skills ensure that our service team can assist you no matter what the issue. With our Service, Sesotec can offer you investment and planning security.



Telephone support

Many questions and incidents can be resolved over the phone. Our free telephone support is available daily from 6 am to 8 pm and on weekends from 8 am to 5 pm. Fast, simple, effective.



Remote Access

Frequently, malfunctions on machines can also be remedied via remote access. Sesotec service technicians have direct access to your machines via Ethernet connection and can perform error analyses, optimizations and parameter settings.



Remote support with augmented reality

In addition to telephone support and remote access, Sesotec also offers video-based support with augmented reality. This is done via the Team-Viewer Pilot app.



Sesotec spare and wear parts packages

With the preventive spare and wear parts package for our devices and systems, you have the supplies you need in the event of machine downtime and can quickly and easily replace mechanical components yourself.

Lifetime Warranty Package for increased OEE

(Overall Equipment Effectiveness)

Life-long guarantee for x-ray tubes and detector

With the Lifetime Warranty Package

- Complete cost control over the lifetime of the device
- Predictive Maintenance

Without Lifetime Warranty Package

- Costs and risks of unplanned downtime
- Unplanned downtime due to tube failure
- Uninspected products must be stored while the problem is resolved (storage costs)
- Costs and resources spent on subsequent investigation

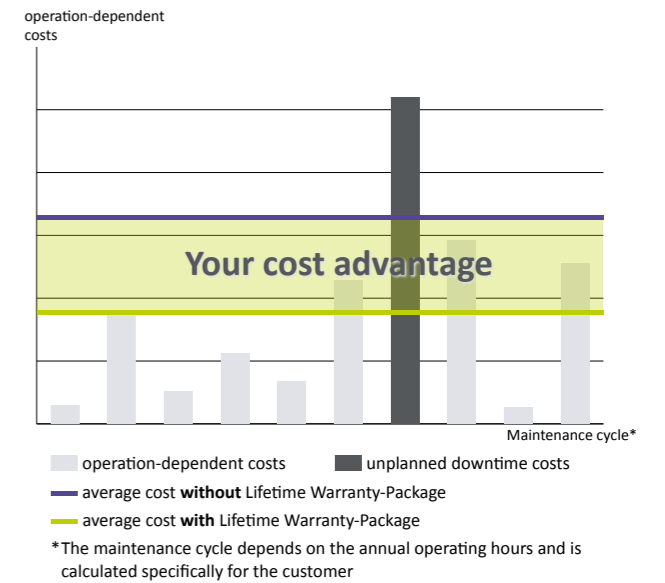

365 days

With global service centers, our support team is available year-round, offering quick response times.

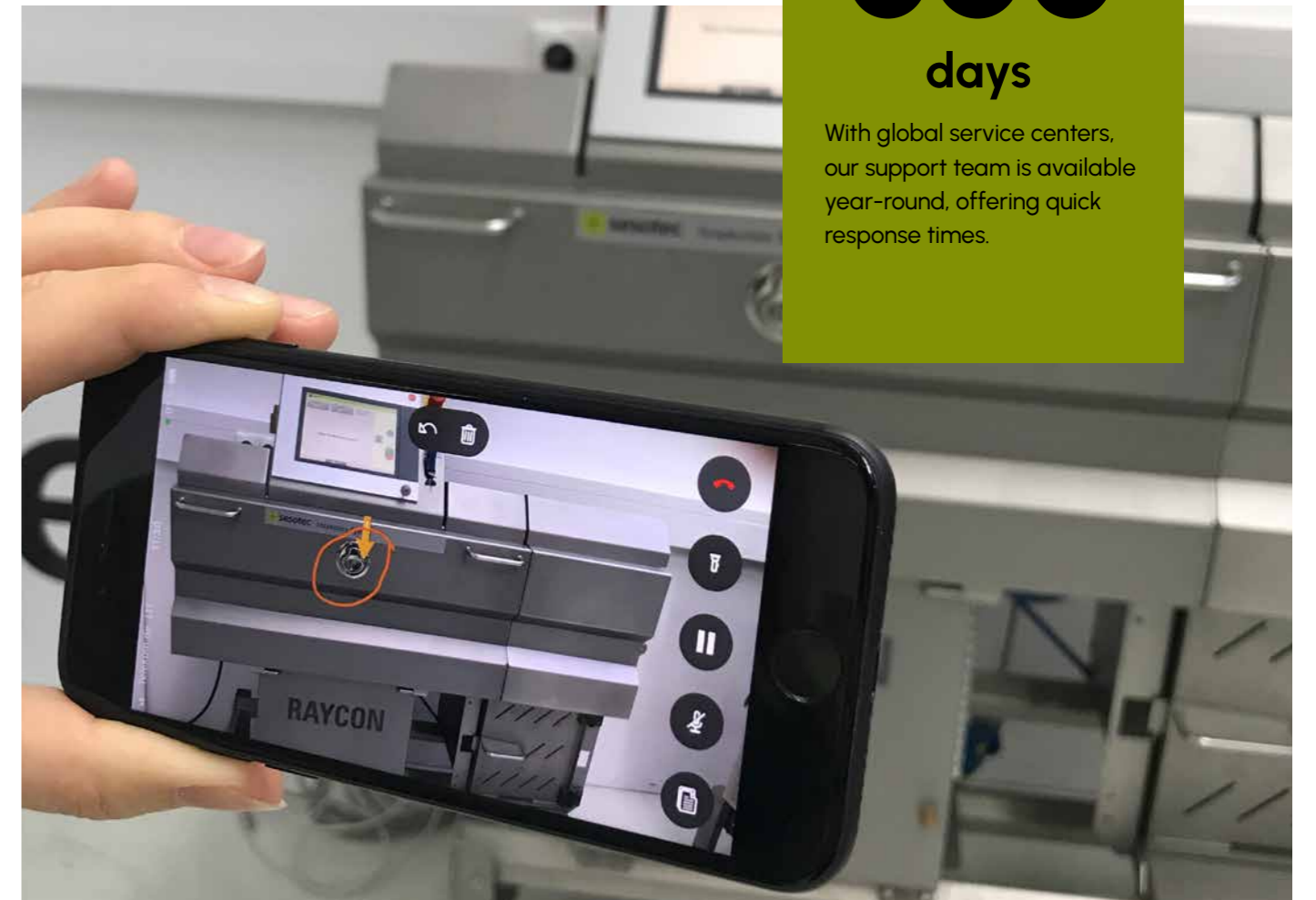

PLEASED TO MEET YOU

The new RAYCON family



RAYCON EX1

An entry-level system for intelligent x-ray inspection of packaged products

**0.8
mm**

Detector

**1000
pcs/min**

Performance *

**60
Watt**

X-ray Source

Compact and effective

With a compact installation length, RAYCON EX1 fits into any production line. With an integrated exit signal, RAYCON EX1 has a total length of only 800 mm, or 1200 mm with an integrated rejection unit.

Auto-learn function

With the Auto-Learn function, RAYCON EX1 offers a simple and intuitive operation. The configuration of various filters is performed by the device itself, considerably reducing effort on the part of the user. Using five product samples, autolearning takes fewer than two minutes for each new product.

Detects product defects

The RAYCON EX1 reliably detects product defects such as missing, broken, or misshapen products.



For packaged products

Free consultation

<https://www.sesotec.com/emea/en/contact>

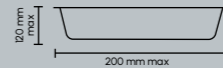

Possible configurations

Belt width	230 mm
X-ray source	40–50 kV / 1.25–1.5 mA (60W)
Detector definition	0.8 mm
Detection accuracy	from Ø 0.6 mm
Conveyance speed	up to 1.4 m/s
Throughput	up to 1000 pcs/min at Ø 66 x H 33 mm 220 pcs/min at L 220 x B 170 x H 20 mm
Max. inspection area (W x H)	200 x 120 mm 
Temperature environment	0 °C to 40 °C
Installation length	800 mm (signal only) 1200 mm (integrated pusher)
Protection type	IP 65 in the conveyor area, IP 54 Entire unit
Rejection system	Exit signal, Integrated rejection system

Optionen

Software Package 1	Completion control, weight check, form deviations, clip recognition
Compliance Package	Audit-Check in standard, IVP optional

Accessories

Insight.360	Sesotec memory module for data archiving
Test samples	In various sizes and configurations

*depending on product

RAYCON EX2

The entry-level model of intelligent X-ray inspection systems for packaged products

0.4 mm

Detector

1000 pcs/min

Performance*

100 Watt

X-ray Source

Compact & effective

Due to its compact overall length, the RAYCON EX2 fits into any production line. With output signal, the RAYCON EX2 has an overall length of 800 mm.

Detection of product defects

The RAYCON EX2 reliably detects reliably product defects such as missing, broken or deformed products.

Auto-learn function

The Auto-Learn function makes the operation of the RAYCON EX2 very simple and intuitive. Thus, the setting of various filters is taken over by the device itself, which makes the user's work much easier. Getting to know new products takes less than 2 minutes – using just five sample products.



*depending on product



For packaged products

Free consultation

<https://www.sesotec.com/emea/en/contact>

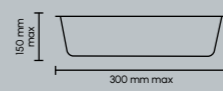
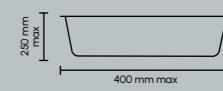

Possible configurations

Belt width	350 mm	650 mm
X-ray source	50 kV / 2.0 mA (100 W)	50 kV / 2.0 mA (100 W)
Detector definition	0.4 mm	0.4 mm
Detection accuracy	from Ø 0.6 mm	from Ø 0.6 mm
Conveyance speed	up to 1.4 m/s	up to 1.4 m/s
Throughput	up to 1000 pcs/min at Ø 66 × H 33 mm 220 pcs/min at L 220 × B 170 × H 20 mm	up to 1000 pcs/min at Ø 66 × H 33 mm 220 pcs/min at L 220 × B 170 × H 20 mm
Max. inspection area (W x H)	300 × 150 mm 	400 × 250 mm 
Temperature environment	0 °C to 40 °C	0 °C to 40 °C
Installation length	800 mm (signal only) 1600 mm (with separate rejection system)	800 mm (signal only) 1600 mm (with separate rejection system)
Protection type	IP65 in the conveyor area IP54 Entire unit	IP65 in the conveyor area IP54 Entire unit
Rejection system	Exit signal Separate rejection system	Exit signal Separate rejection system

Options

Software Package 1	Completion control, weight check, form deviations, clip recognition
Compliance Package	Audit-Check in standard, IVP optional

Accessories

Insight.360	Sesotec memory module for data archiving
Test samples	In various sizes and configurations

RAYCON D+ MX

The standard system for intelligent x-ray inspection of packaged products

0.8

mm
optional 0.4mm

Detector

1500

pcs/min

Performance*

100

Watt

X-ray Source

Multi-Lane

The RAYCON D+ MX can simultaneously inspect up to four lines of products, making it possible to inspect identical products from different production lines on a single device.

Zone Analyzer

The Zone Analyzer software allows for the definition of different zones within an x-ray image. This makes it possible to carry out counting and weighing for individual zones using optimal sensitivity settings for each.

Multi-product

As many as 20 different products can be conveyed in any order. The software recognizes each product as it passes through the x-ray beam and selects the appropriate parameters within milliseconds.



For packaged products

Free consultation

<https://www.sesotec.com/emea/en/contact>

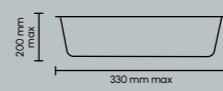
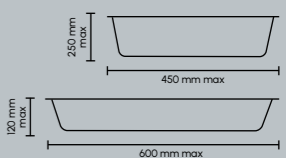

Possible configurations

Belt width	360 mm	660 mm
X-ray Source	40–50 kV / 2.0–2.5 mA (100 W)	40–50 kV / 2.0–2.5 mA (100 W)
Detector definition	0.8 mm (optional 0.4 mm)	0.8 mm (optional 0.4 mm)
Detection accuracy	from Ø 0.6 mm (optional from Ø 0.4 mm)	from Ø 0.6 mm (optional from Ø 0.4 mm)
Conveyance speed	up to 1.4 m/s	up to 1.4 m/s
Throughput	up to 1500 pcs/min at Ø 66 × H 33 mm 220 pcs/min at L 220 × B 170 × H 20 mm	up to 1500 pcs/min at Ø 66 × H 33 mm 220 pcs/min at L 220 × B 170 × H 20 mm
Max. inspection area (W x H)	330 × 200 mm 	450 × 250 mm 600 × 120 mm 
Temperature environment	0 °C to 30 °C (option of cooling device for temperatures up to 40 °C)	0 °C to 30 °C (option of cooling device for temperatures up to 40 °C)
Installation length	1400 mm (signal only) 1900 mm (integrated pusher)	1400 mm (signal only)
Protection type	IP66 in the conveyor area IP54 Entire unit (IP55 with optional cooling device)	IP66 in the conveyor area IP54 Entire unit (IP55 with optional cooling device)
Rejection system	Exit signal, Integrated rejection system, Separate rejection system	Exit signal, Separate rejection system, Separate rejection system

Options

Software Package 1 (inclusive)	Completion control, weight check, form deviations, clip recognition	Insight.360 Sesotec memory module for data archiving
Software Package 2	Multi-Lane, Multi-Product, Zone-Analyzer	
Compliance Package	Audit-Check, IVP optional	
Login Package	Expanded login functionality	
		Test samples In various sizes and configurations

Accessories

*depending on product

RAYCON D+ HX

The high-end system for intelligent x-ray inspection of packaged products

0.4 mm

Detector

900 pcs/min

Performance*

200 Watt

X-ray Source

New software filters

Newly developed software filters improve the detection accuracy for specific, low-density contaminants. The Glass Increaser, for example, optimizes the detection of glass fragments, while the Bone Detector improves the detectability of fragments of bone and cartilage. In addition, the Wire Finder can reliably detect smaller, elongated pieces of wire.

Sensitivity prediction

Sensitivity prediction makes it possible to automatically configure the best detection sensitivity for stainless steel and glass. Data about hundreds of test pieces for glass and stainless steel are stored in the software. This information is calculated along with the product's gray value image, as if a product with a test piece were being recorded.

Compliance Package

Integrated Compliance Monitoring ensures that the specified sensitivity levels are continuously verified at predefined time intervals. This monitoring of detection requirements enables immediate identification of deviations and increases the stability of the production process. Additional compliance features are available as optional add-ons.

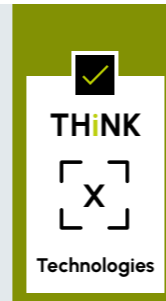

For packaged products

Free consultation

<https://www.sesotec.com/emea/en/contact>

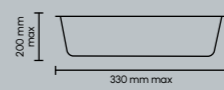
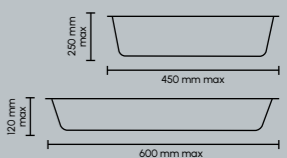

Possible configurations

Belt width	360 mm	660 mm
X-ray Source	40–100 kV / 2.0–5.0 mA (200 W)	40–100 kV / 2.0–5.0 mA (200 W)
Detector definition	0.4 mm	0.4 mm
Detection accuracy	from Ø 0.4 mm	from Ø 0.4 mm
Conveyance speed	up to 1.4 m/s	up to 1.4 m/s
Throughput	up to 900 pcs/min at Ø 66 x H 33 mm 220 pcs/min at L 220 x B 170 x H 20 mm	up to 900 pcs/min at Ø 66 x H 33 mm 220 pcs/min at L 220 x B 170 x H 20 mm
Max. inspection area (W x H)	330 x 200 mm 	450 x 250 mm 600 x 120 mm 
Temperature environment	0 °C to 40 °C	0 °C to 35 °C
Installation length	1400 mm (signal only) 1900 mm (integrated pusher)	1400 mm (signal only)
Protection type	IP66 in the conveyor area, IP55 Entire unit	IP66 in the conveyor area, IP55 Entire unit
Rejection system	Exit signal, Integrated rejection system, Separate rejection system	Exit signal, Integrated rejection system, Separate rejection system

Options

Software Package 1 (inclusive)	Completion control, weight check, form deviations, clip recognition
Software Package 2	Multi-Lane, Multi-Product, Zone-Analyzer
Software Package 3 (inclusive)	Sensitivity prediction and compliance mode
Compliance Package	Audit-Check, Compliance Mode and Sensitivity Prediction (standard), ICM and IVP optional
Login Package	Expanded login functionality
THINK X	Anomaly detection and/or object detection based on artificial intelligence (software + hardware)

Accessories

Insight.360	Sesotec memory module for data archiving
Test samples	In various sizes and configurations

*depending on product

RAYCON D+ TX

The high-end system for intelligent x-ray inspection of packaged products

0.4 mm

Detector

1500 pcs/min

Performance*

200 Watt

X-ray Source

New software filters

The newly developed High Precision software filter, specifically designed for detecting the smallest contaminants, improves the detection accuracy of low-density foreign objects. In addition, the Glassincreaser enhances the detection of glass shards, the Bonedetector identifies bones and cartilage, and the Wirefinder reliably detects small, elongated wire shapes.

TDI detector

The sensitivity prediction automatically determines the detection sensitivity for stainless steel and glass. The software includes a database of 100-type test cards in all sizes, which are digitally superimposed onto the grayscale image of the product—as if a real scan with a test card had been performed. This ensures exceptionally high detection accuracy, even at high speeds.

Compliance Package

Integrated Compliance Monitoring ensures that the specified sensitivity levels are continuously verified at predefined time intervals. This monitoring of detection requirements enables immediate identification of deviations and increases the stability of the production process. Additional compliance features are available as optional add-ons.

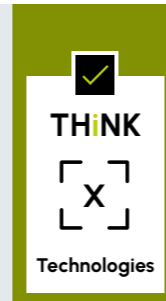

For packaged products

Free consultation

<https://www.sesotec.com/emea/en/contact>

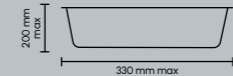

Possible configurations

Belt width	360 mm
X-ray source	40–60 kV / 3.3–5.0 mA (200 W)
Detector definition	TDI detector
Detection accuracy	from Ø 0.3 mm (from 0.4 mm at 1.4 m/s)
Conveyance speed	up to 1.4 m/s
Throughput	up to 900 pcs/min at Ø 66 × H 33 mm 220 pcs/min at L 220 × B 170 × H 20 mm
Max. inspection area (W x H)	330 × 200 mm 
Temperature environment	0 °C to 40 °C
Installation length	1400 mm (signal only) 1900 mm (integrated pusher)
Protection type	IP66 in the conveyor area, IP55 Entire unit
Rejection system	Exit signal, Integrated rejection system, Separate rejection system

Options

Software Package 1 (inclusive)	Completion control, weight check, form deviations, clip recognition
Software Package 2	Multi-Lane, Multi-Product, Zone-Analyzer
Software Package 3 (inclusive)	Sensitivity prediction and compliance mode
Compliance Package	Audit check, compliance mode, sensitivity prediction (standard), ICM and IVP optional
Login Package	Expanded login functionality
THINK X	Anomaly detection and/or object detection based on artificial intelligence (software + hardware)

Accessories

Insight.360	Sesotec memory module for data archiving
Test samples	In various sizes and configurations

*depending on product

RAYCON D+ MX LW

The standard system for intelligent, curtainless x-ray inspection of lightweight or sharp-edged packaged products.

0.8

mm
optional 0.4mm

Detector

1500

pcs/min

Performance*

100

Watt

X-ray Source

Curtainless machine

Designed free of curtains, the RAYCON D+ MX LW is perfect for inspecting lightweight products.

Multi-lane

The RAYCON D+ MX can simultaneously inspect up to four lines of products, making it possible to inspect identical products from different production lines on a single device.

Detects product defects

The RAYCON D+ MX LW reliably detects product defects such as missing, broken, or misshapen products.





For lightweight or sharp-edged packaged products

Free consultation

<https://www.sesotec.com/emea/en/contact>



Possible configurations

Belt width	360 mm	660 mm
X-ray source	40–50 kV / 2.0–2.5 mA (100 W)	40–50 kV / 2.0–2.5 mA (100 W)
Detector definition	0.8 mm (optional 0.4 mm)	0.8 mm (optional 0.4 mm)
Detection accuracy	from Ø 0.6 mm (optional from Ø 0.4 mm)	from Ø 0.6 mm (optional from Ø 0.4 mm)
Conveyance speed	up to 1.4 m/s	up to 1.4 m/s
Throughput	up to 1500 pcs/min at Ø 66 × H 33 mm 220 pcs/min at L 220 × B 170 × H 20 mm	up to 1500 pcs/min at Ø 66 × H 33 mm 220 pcs/min at L 220 × B 170 × H 20 mm
Max. inspection area (W x H)	330 × 50 mm 	430 × 50 mm 
Temperature environment	0 °C to 30 °C (option of cooling device for temperatures up to 40 °C)	0 °C to 30 °C (option of cooling device for temperatures up to 35 °C)
Installation length	1500 (signal only) 1750 mm (integrated pusher)	1500 (signal only) 1750 mm (integrated pusher)
Protection type	IP66 in the conveyor area IP54 Entire unit (IP55 with optional cooling device)	IP66 in the conveyor area IP54 Entire unit (IP55 with optional cooling device)
Rejection system	Exit signal, Integrated rejection system with 1 or 2 flaps, Separate rejection system	Exit signal, Integrated rejection system with 1 or 2 flaps, Separate rejection system

Options

Software Package 1 (inclusive)	Completion control, weight check, form deviations, clip recognition	Insight.360 Sesotec memory module for data archiving
Software Package 2	Multi-Lane, Multi-Product, Zone-Analyzer	
Compliance Package	Audit-Check in standard, IVP optional	
Login Package	Expanded login functionality	
		Test samples In various sizes and configurations

Accessories

*depending on product

RAYCON D+ HX LW

The high-end system for intelligent, curtainless x-ray inspection of lightweight or sharp-edged packaged products

0.4 mm

Detector

900 pcs/min

Performance*

200 Watt

X-ray Source

New software filters

Newly developed software filters improve the detection accuracy for specific, low-density contaminants. The Glass Increaser, for example, optimizes the detection of glass fragments, while the Bone Detector improves the detectability of fragments of bone and cartilage. In addition, the Wire Finder can reliably detect smaller, elongated pieces of wire.

Sensitivity prediction

Sensitivity prediction makes it possible to automatically configure the best detection sensitivity for stainless steel and glass. Data about hundreds of test pieces for glass and stainless steel are stored in the software. This information is calculated along with the product's gray value image as if a product with a test piece were being recorded.

Self-monitoring

Integrated Compliance Monitoring ensures that specified sensitivities are continuously checked at predefined time intervals. Through regular controls of the detection requirements, deviations are immediately detected, increasing the consistency of the production process.

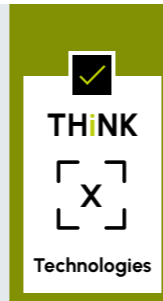



For lightweight or sharp-edged packaged products

Free consultation

<https://www.sesotec.com/emea/en/contact>



Possible configurations

Belt width	360 mm	660 mm
X-ray Source	40–60 kV / 3.3–5.0 mA (200 W)	40–60 kV / 3.3–5.0 mA (200 W)
Detector definition	0.4 mm	0.4 mm
Detection accuracy	from Ø 0.4 mm	from Ø 0.4 mm
Conveyance speed	up to 1.4 m/s	up to 1.4 m/s
Throughput	up to 900 pcs/min at Ø 66 × H 33 mm 220 pcs/min at L 220 × B 170 × H 20 mm	up to 900 pcs/min at Ø 66 × H 33 mm 220 pcs/min at L 220 × B 170 × H 20 mm
Max. inspection area (W x H)	330 × 50 mm 	630 × 50 mm 
Temperature environment	0 °C to 30 °C (option of cooling device for temperatures up to 40 °C)	0 °C to 30 °C (option of cooling device for temperatures up to 35 °C)
Installation length	1500 mm (signal only) 1750 mm (integrated pusher)	1500 mm (signal only) 1750 mm (integrated pusher)
Protection type	IP66 in the conveyor area IP55 Entire unit	IP66 in the conveyor area IP55 Entire unit
Rejection system	Exit signal, Integrated rejection system with 1 or 2 flaps, Separate rejection system	Exit signal, Integrated rejection system with 1 or 2 flaps, Separate rejection system

Options

Software Package 1 (inclusive)	Completion control, weight check, form deviations, clip recognition
Software Package 2	Multi-Lane, Multi-Product, Zone-Analyzer
Software Package 3 (inclusive)	Sensitivity prediction and compliance mode
Compliance Package	Audit check, compliance mode, sensitivity prediction (standard), ICM and IVP optional
Login Package	Expanded login functionality
THINK X	Anomaly detection and/or object detection based on artificial intelligence (software + hardware)

Accessories

Insight.360	Sesotec memory module for data archiving
Test samples	In various sizes and configurations

*depending on product

RAYCON D+ MX Bulk

The standard system for intelligent x-ray inspection of unpackaged products

0.8 mm

Detector

to **13.5 t/h**

Performance*

100 Watt

X-ray Source

Real-time operating system

Fastest image data processing and an exact rejection rate; very high detection accuracy from 0.6 mm.

High processing capacity

The RAYCON D+ MX Bulk can inspect up to 13.5 tons per hour at a fill height of 20 mm.

Hygienic design concept

An optional dust extraction system enables the RAYCON D+ MX Bulk to minimize dust accumulation in the vicinity of the product sorting unit.



For unpackaged products

Free consultation

<https://www.sesotec.com/emea/en/contact>

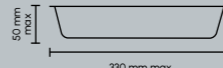
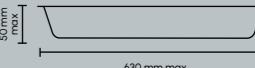

Possible configurations

Belt width	360 mm	660 mm
X-ray source	40–50 kV / 2.0–2.5 mA (100 W)	40–50 kV / 2.0–2.5 mA (100 W)
Detector definition	0.8 mm	0.8 mm
Detection accuracy	from Ø 0.6 mm	from Ø 0.6 mm
Conveyance speed	up to 1.3 m/s	up to 1.3 m/s
Throughput	up to 7 t/h	up to 13.5 t/h
Max. inspection area (W x H)	330 x 50 mm 	630 x 50 mm 
Temperature environment	0 °C to 30 °C (option of cooling device for temperatures up to 40 °C)	0 °C to 30 °C (option of cooling device for temperatures up to 40 °C)
Installation length	1800 mm (integrated flaps)	1800 mm (integrated flaps)
Protection type	IP66 in the conveyor area IP54 Entire unit (IP55 with optional cooling device)	IP66 in the conveyor area IP54 Entire unit (IP55 with optional cooling device)
Rejection system	Integrated rejection system with 4 flaps (option of up to 10 flaps)	Integrated rejection system with 4 flaps (option of up to 20 flaps)

Options

Compliance Package	Audit-Check in standard
Login Package	Expanded login functionality

Accessories

Insight.360
Sesotec memory module for data archiving

Test samples
In various sizes and configurations

*depending on product

RAYCON D+ HX Bulk

The high-end system for intelligent x-ray inspection of unpackaged products

0.4
mm

Detector

to
13.5
t/h

Performance*

200
Watt

X-ray Source

Real-time operating system

Fastest image data processing and an exact rejection rate; very high detection accuracy from 0.3 mm.

Maximum flexibility

The machine is equipped as standard with a rejection system featuring four separate, pneumatically operated flaps. To minimize loss of good material, the rejection system can optionally be expanded to up to 20 flaps or segmented air nozzles.

Consistent product distribution

The RAYCON D+ HX Bulk features an integrated feed hopper with an optional vibratory chute to ensure uniform distribution of bulk material across the entire conveyor belt width.





For unpackaged products

Free consultation

<https://www.sesotec.com/emea/en/contact>



Possible configurations

Belt width	360 mm	660 mm
X-ray source	40–60 kV / 3.3–5.0 mA (200 W)	40–60 kV / 3.3–5.0 mA (200 W)
Detector definition	0.4 mm	0.4 mm
Detection accuracy	from Ø 0.4 mm	from Ø 0.4 mm
Conveyance speed	up to 1.3 m/s	up to 1.3 m/s
Throughput	up to 7 t/h	up to 13.5 t/h
Max. inspection area (W x H)	330 x 50 mm 	630 x 50 mm 
Temperature environment	0 °C to 40 °C	0 °C to 35 °C
Installation length	1800 mm (integrated flaps)	1800 mm (integrated flaps)
Protection type	IP66 in the conveyor area IP55 Entire unit	IP66 in the conveyor area IP55 Entire unit
Rejection system	Integrated rejection system with 4 flaps (option of up to 10 flaps)	Integrated rejection system with 4 flaps (option of up to 20 flaps)

Options

Compliance Package	Audit-Check in Standard
Login Package	Expanded login functionality

Accessories

Insight.360 Sesotec memory module for data archiving
Test samples In various sizes and configurations

*depending on product

RAYCON D+ HX LW Hygienic

The high-end system for intelligent x-ray inspection of packaged products

0.4 mm

Detector

900 pcs / min

Performance*

200 Watt

X-ray Source

New software filters

The newly developed software filters improve the detection accuracy of low-density foreign objects. The Bonedetector optimizes the identification of bones and cartilage, while the Glassincreaser enhances the detection of glass shards. In addition, the Wirefinder reliably detects even small, elongated wire shapes.

Compliance Package

Integrated Compliance Monitoring ensures that the specified sensitivity levels are continuously verified at predefined time intervals. This monitoring of detection requirements enables immediate identification of deviations and increases the stability of the production process. Additional compliance features are available as optional add-ons.

Hygienic Design

The RAYCON system is designed without curtains and features sturdy casters, polished surfaces, and passive cooling instead of filter fans or air conditioning units. All components (monitor, key switch, signal light, drum motor, etc.) of the RAYCON D+ HX LW Hygienic are rated to protection class IP69. Safety symbols and the nameplate are laser-etched as pictograms, replacing less durable adhesive labels.

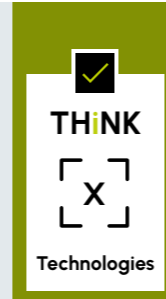

*depending on product



For unpackaged products

Free consultation

<https://www.sesotec.com/emea/en/contact>

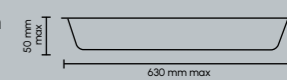

Possible configurations

Belt width	360 mm	660 mm
X-ray Source	40–60 kV / 3.3–5.0 mA (200 W)	40–60 kV / 3.3–5.0 mA (200 W)
Detector definition	0.4 mm	0.4 mm
Detection accuracy	from Ø 0.4 mm	from Ø 0.4 mm
Conveyance speed	up to 1.4 m/s	up to 1.4 m/s
Throughput	up to 900 pcs/min at Ø 66 × H 33 mm 300 pcs/min at L 220 × B 170 × H 20 mm	up to 900 pcs/min at Ø 66 × H 33 mm 300 pcs/min at L 220 × B 170 × H 20 mm
Max. inspection area (W x H)	330 × 50 mm 	630 × 50 mm 
Temperature environment	2 °C to 12 °C (Passive cooling)	2 °C to 12 °C (Passive cooling)
Installation length	1500 mm (signal only) 1750 mm (integrated flap)	1500 mm (signal only) 1750 mm (integrated flap)
Protection type	IP69	IP69
Rejection system	Retract Belt, Integrated rejection system with 1 or 2 flaps	Retract Belt, Integrated rejection system with 1 or 2 flaps

Options

Software Package 1 (inclusive)	Completion control, weight check, form deviations, clip recognition	Insight.360 Sesotec memory module for data archiving
Software Package 2	Multi-Lane, Multi-Product, Zone-Analyzer	
Software Package 3 (inclusive)	Sensitivity prediction and compliance mode	Test samples In various sizes and configurations
Compliance Package	Audit check, compliance mode, sensitivity prediction (standard), ICM and IVP optional	
Login Package	Expanded login functionality	
THiNK X	Anomaly detection and/or object detection based on artificial intelligence (software + hardware)	

Accessories

RAYCON D+ HX Bulk Hygienic

The high-end system for intelligent x-ray inspection of packaged products

0.4
mm

Detector

900
pcs / min

Performance*

200
Watt

X-ray Source

New software filters

The newly developed software filters improve the detection accuracy of low-density foreign objects. The Bonedetector optimizes the identification of bones and cartilage, while the Glassincreaser enhances the detection of glass shards. In addition, the Wirefinder reliably detects even small, elongated wire shapes.

Optimized image processing

Two operating modes are available. In Bulk Mode, continuous images of bulk material are captured, with only defective products shown on the main screen while accepted products are processed in the background. In Bulk Object Mode, each product is captured individually, enabling more precise sorting and accurate piece counting.

Hygienic Design

The RAYCON system is designed without curtains and features sturdy casters, polished surfaces, and passive cooling instead of filter fans or air conditioning units. All components (monitor, key switch, signal light, drum motor, etc.) of the RAYCON D+ HX BO Hygienic are rated to protection class IP69. Safety symbols and the nameplate are laser-etched as pictograms, replacing less durable adhesive labels.





For unpackaged products

Free consultation

<https://www.sesotec.com/emea/en/contact>



Possible configurations

Belt width	360 mm	660 mm
X-ray source	40–60 kV / 3.3–5.0 mA (200 W)	40–60 kV / 3.3–5.0 mA (200 W)
Detector definition	0.4 mm	0.4 mm
Detection accuracy	from Ø 0.4 mm	from Ø 0.4 mm
Conveyance speed	up to 1.4 m/s	up to 1.4 m/s
Throughput	up to 900 pcs/min at Ø 66 × H 33 mm 300 pcs/min at L 220 × B 170 × H 20 mm	up to 900 pcs/min at Ø 66 × H 33 mm 300 pcs/min at L 220 × B 170 × H 20 mm
Max. inspection area (W x H)	330 × 50 mm 	630 × 50 mm 
Temperature environment	2 °C to 12 °C (Passive cooling)	2 °C to 12 °C (Passive cooling)
Installation length	1500 mm (signal only) 1750 mm (integrated flap)	1500 mm (signal only) 1750 mm (integrated flap)
Protection type	IP69	IP69
Rejection system	Retract Belt, Integrated rejection system with 1 or 2 flaps	Retract Belt, Integrated rejection system with 1 or 2 flaps

Options

Software Package 1 (inclusive)	Completion control, weight check, form deviations, clip recognition	Insight.360 Sesotec memory module for data archiving Test samples In various sizes and configurations
Software Package 2	Multi-Lane, Multi-Product, Zone-Analyzer	
Software Package 3 (inclusive)	Sensitivity prediction and compliance mode	
Compliance Package	Audit check, compliance mode, sensitivity prediction (standard), ICM and IVP optional	
Login Package	Expanded login functionality	

Accessories

*depending on product

RAYCON is flexible and can be adapted to fit your needs

Software Package 1

included as standard

Completion control

For each object marked for counting in the x-ray image, minimum amounts can be configured. E.g. the number of chocolates in a box.

Misshapen products

The software recognizes broken and misshapen products from within their packaging.

Weight checking

The software calculates the weight of the product based on dimensions and density, thereby recognizing weight differences among individual products in a line.

Clip recognition

This feature makes it possible to ignore the gray value of the metal clips used to package a product and proceed with the optimal detection sensitivity for the inside of the product.

Software Package 2

Multi-lane

This software package allows for the simultaneous inspection of up to four lines of products, making it possible to inspect identical products from different product lines on a single device.

Multi-product

Allows for the conveyance of up to 20 different products in any order. The software recognizes each product as it passes through the x-ray beam and selects the appropriate parameters within milliseconds.

Zone Analyzer

Allows for the definition of different zones within an x-ray image. Counting and weighing parameters can be defined for each zone, ensuring the best sensitivity settings are used for each.

Software Package 3

included as standard

Sensitivity prediction

Makes it possible to automatically configure the best detection sensitivity for stainless steel and glass. Data about hundreds of test pieces for glass and stainless steel are stored in the software. This information is calculated along with the product's gray value image, as if a product with a test piece were being recorded.

Compliance Mode

With the Compliance Mode, the detection sensitivity can be set to a factory/ or audit standard to produce compliantly and maintain constant process stability. The X-ray unit directly adjusts the software filters to the compliance mode values during the teach-in process in order to reliably detect the specified test samples.

Insight.WEB is a web-solution for the operation and monitoring of all metal detectors and X-ray inspection systems from a central control station.

- Our foreign object detection systems record operating data such as contamination detection, product changes, audit checks, and error messages in a log. Each data entry is timestamped and dated.
- Insight.WEB is a central data management software for monitoring and operating all metal detectors and X-ray systems from a central control station (e.g., smartphone or laptop). For you, this means that you can read, save, load, and delete all logged operating data (e.g., system logbook) while simultaneously accessing and remotely controlling all connected systems – anytime and anywhere.

INTERLINK+ is a communication module for the digital integration of Sesotec devices into central company networks. It enables targeted productivity increases through central process analysis, monitoring, and control, as provided for in Industry 4.0.

- Networking via OPC UA or REST-API
- Targeted productivity increase through central process analysis, monitoring, and control
- Enables central control of Sesotec inspection devices as well as remote maintenance and predictive maintenance
- Enables early detection of errors and wear through cross-device data comparison



Want to learn more about our technology for food manufacturing?

Get in touch with us directly! We look forward to advising you. You can reach us at:

+49 (0) 8554 308-0 www.sesotec.com

Compliant & secure with Insight.360

Insight.360 offers a wide range of features to help you monitor the manufacturing process. Through optimal traceability, a comprehensive logbook and efficient data management, you are kept informed of the status of your equipment at all times.

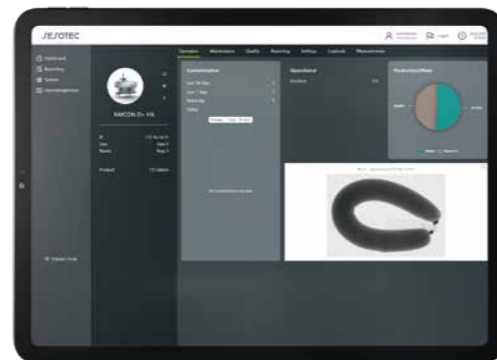

Imprint

SESOTEC

Sesotec GmbH
Regener Strasse 130
D-94513 Schönberg

Phone: +49 (0) 8554 / 308-0
Mail: info@sesotec.com
Website: www.sesotec.com

Managing Director:
Joachim Schulz | CEO
Niklas Burkart | CFO

Register Court: Local Court of Passau
Commercial register no. HRB 3163
VAT ID: DE 81 151 25 77

Concept, text, design:
Sesotec GmbH

Picture credits/Copyright:
All image rights reserved by
the company Sesotec GmbH.

